



5+



11



2,4m



1 = 3,5m 2 = 2,4m 3 = 2,4m

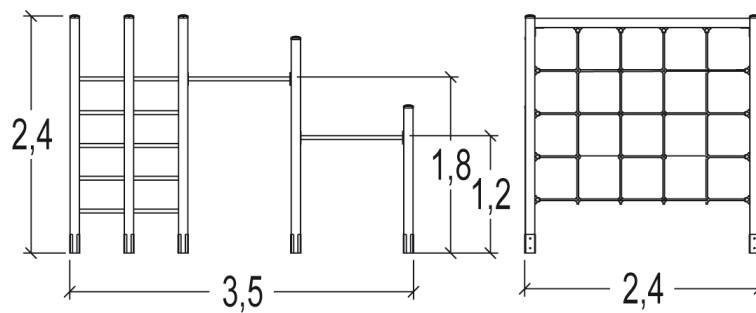
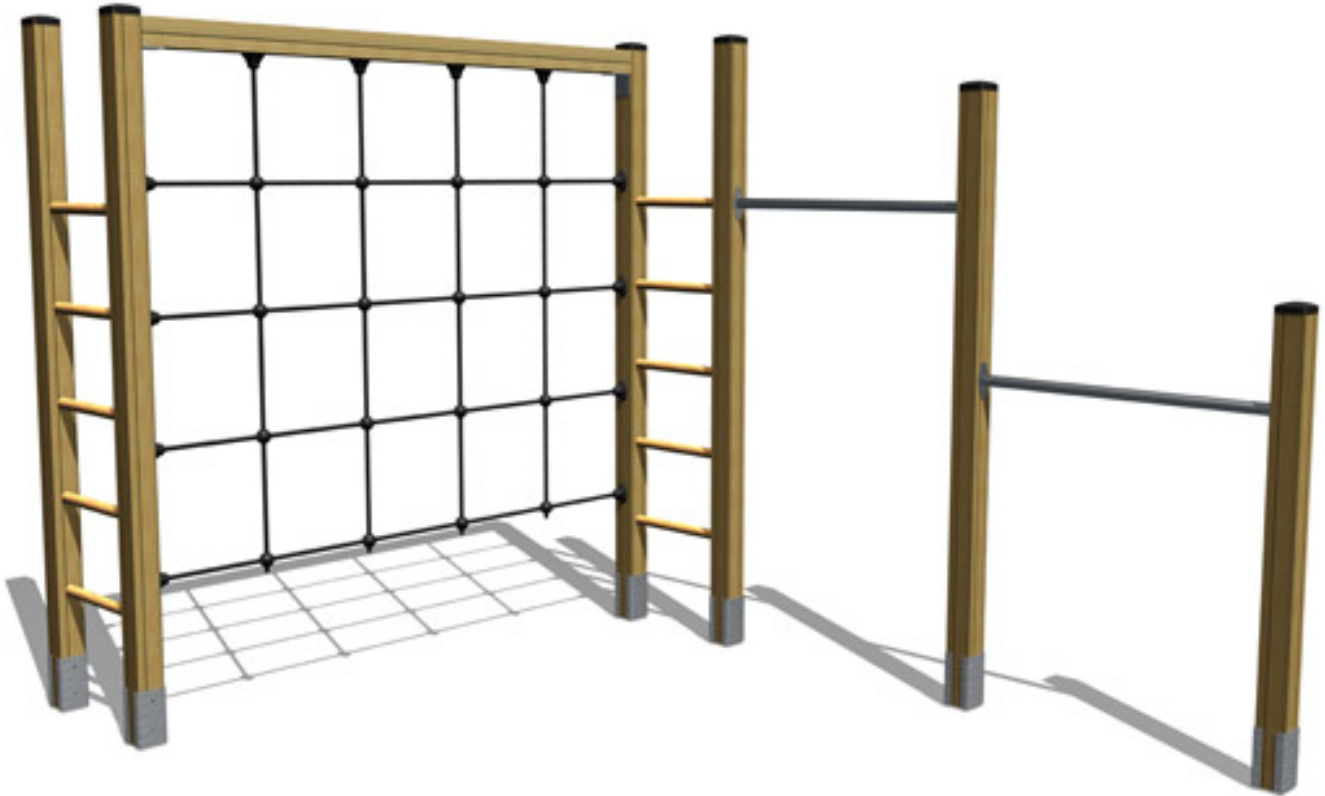

Play value

hanging



x1

climbing



x2

Number of play elements: 3

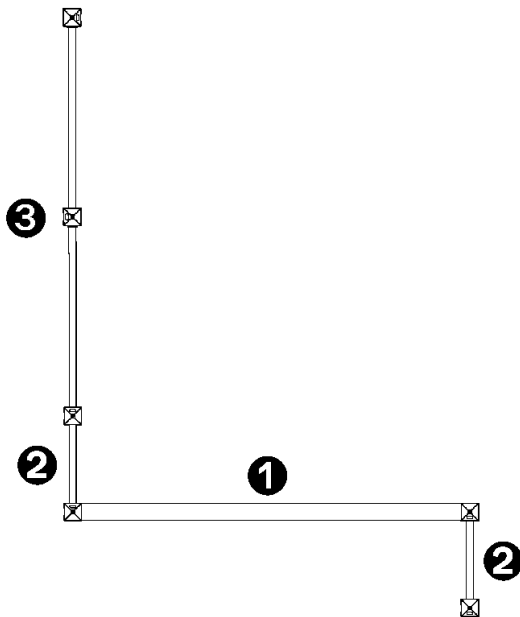



- ① Climbing net - G1605
- ② Step ladder - G1609
- ③ Horizontal bar HT: 1.2m et 1.8m - G1610

Installation of equipment

Impact area =

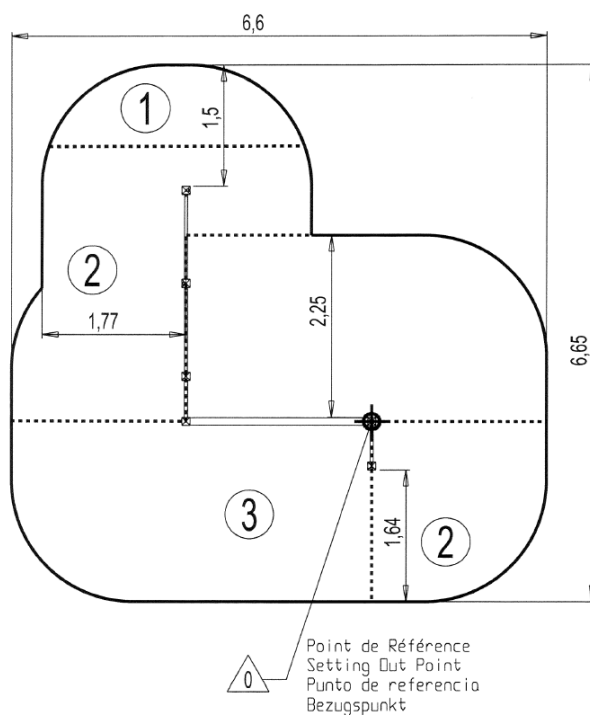
— Impact area
 - - - Free space



		
1	1,20m	2,5m ²
2	1,8m	13m ²
3	2,4m	19,5m ²



2



03h00



0.2m³



35m²



142kg



27kg

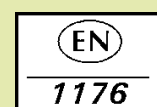

Proludic

2013-08-27