



6+



2



0,6m



1 = 0,48m 2 = 0,48m 3 = 0,38m

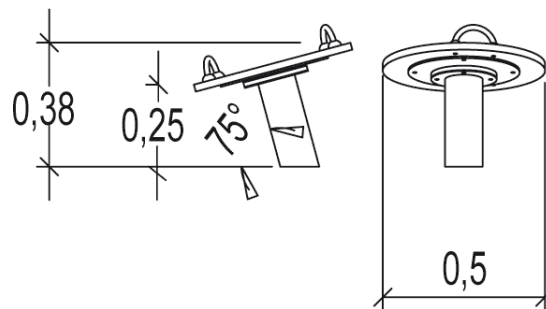
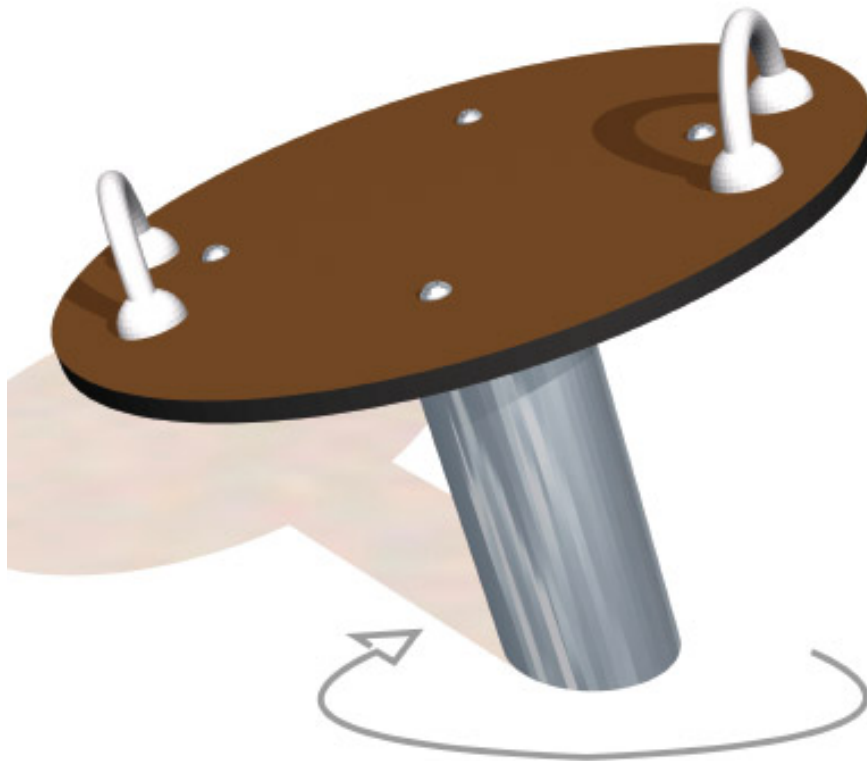

**Play value**

balancing      meeting / role play





**Accessibility**

Motor disability

 Sensorial Disabilities

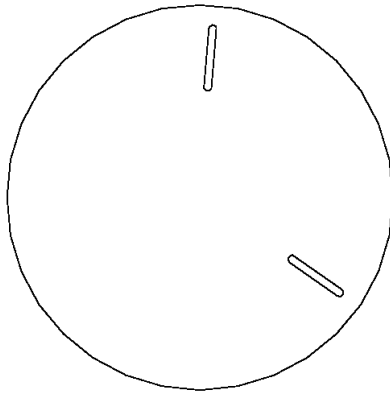
Learning Disabilites









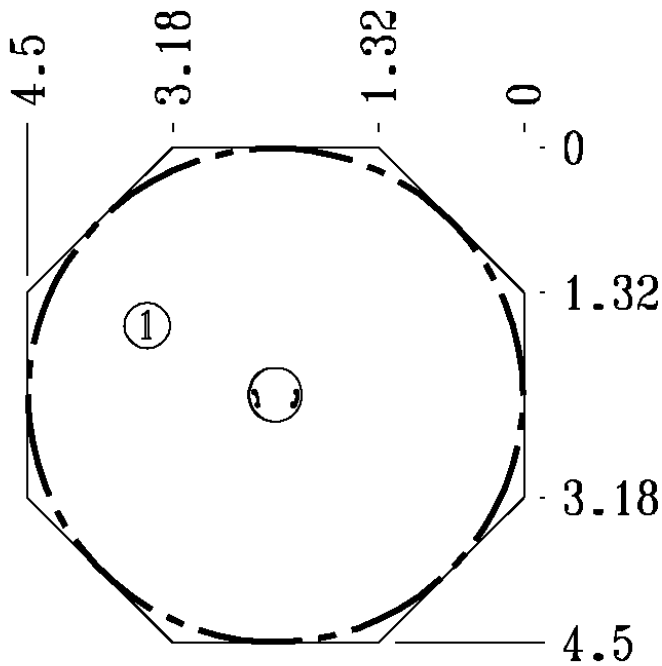



## Installation of equipment

Impact area =

-  Impact area
-  Free space

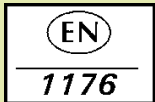

	
1	0,6m
	17m <sup>2</sup>

							
1	01h45	0.1m <sup>3</sup>	17m <sup>2</sup>	29kg	25kg		2002-06-11