



2-6



4



0,6m



1 = 1,67m 2 = 0,94m 3 = 1,03m

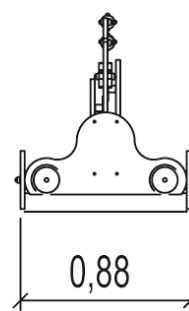
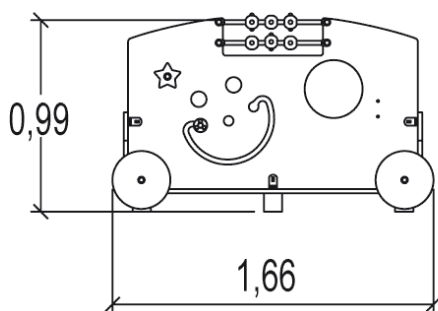

## Play value

handling



meeting / role play



## Accessibility



Motor disability



Sensorial Disabilities

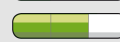

Learning Disabilities



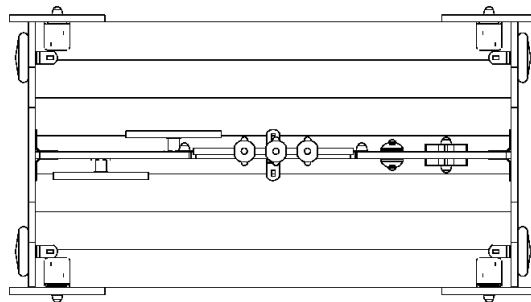







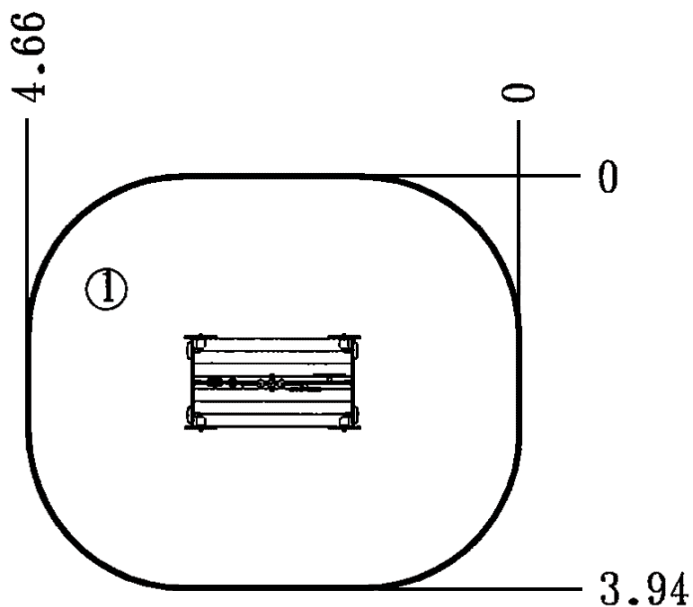





## Installation of equipment

Impact area =

-  Impact area
-  Free space

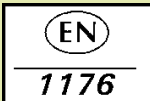

		
1	0,6m	16,5m <sup>2</sup>

								
2	02h00	0.11m <sup>3</sup>	16.5m <sup>2</sup>	79kg	35kg			2012-12-17