



1-8



6



0,3m



1 = 1,5m 2 = 0,75m 3 = 1,6m

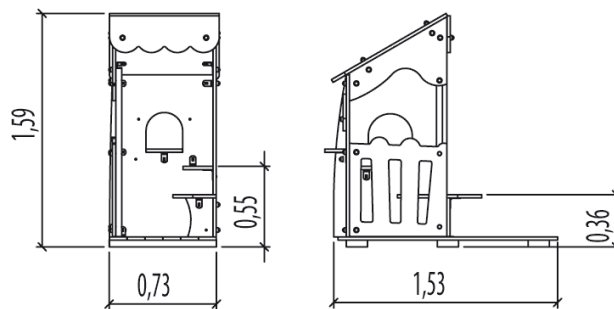

Play value

meeting / role play



hiding / resting



Accessibility



Motor disability

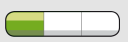

Sensorial Disabilities

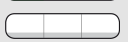

Learning Disabilites



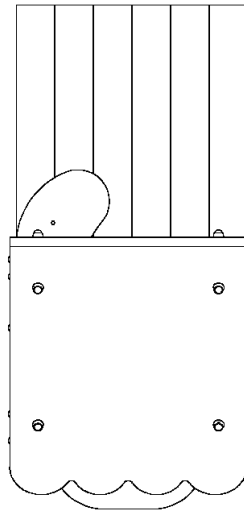



Installation of equipment

Impact area =

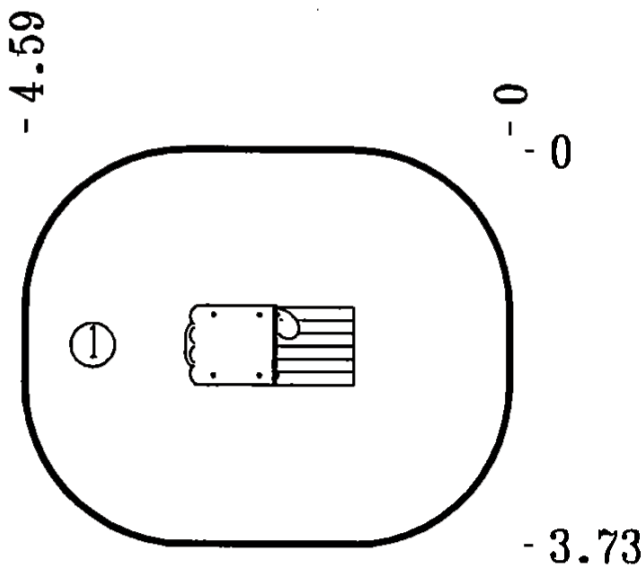
 Impact area
 Free space



		
1	0,30m	15,5m ²



2



01h30



0.1m³



15.5m²



84kg



27kg

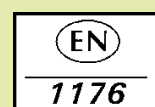

Proludic

2007-01-01