

# Springers

J802



2+



1



0,55m



1 = 0,93m 2 = 0,32m 3 = 0,86m

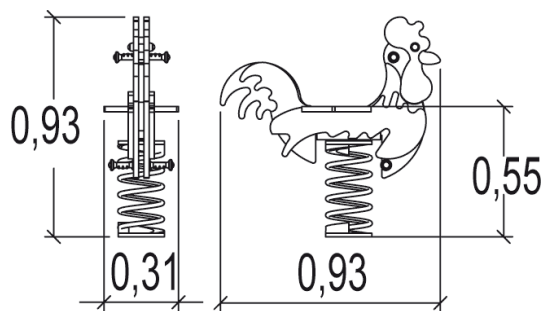

## Play value

swinging



balancing



## Accessibility



Motor disability



Sensorial Disabilities

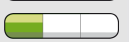

Learning Disabilities

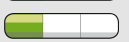

*Proludic*

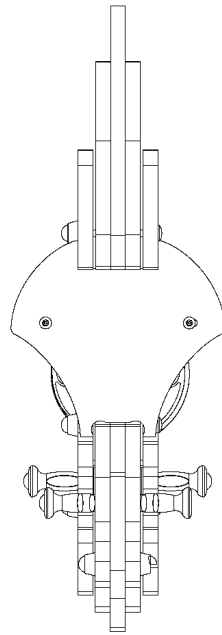



## Installation of equipment

Impact area =

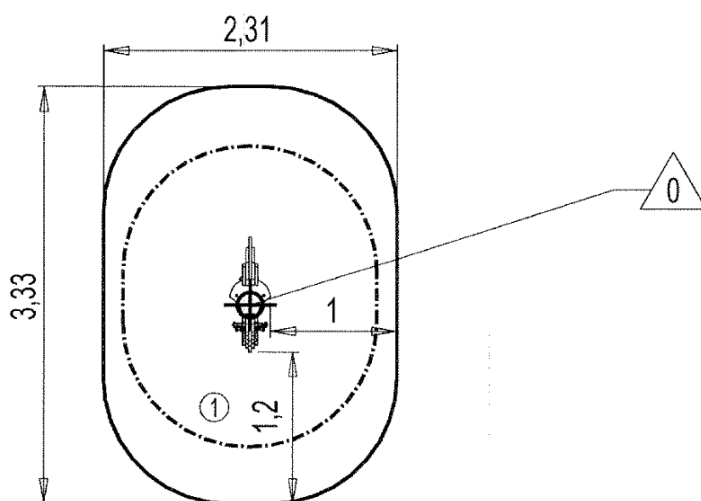
-  Impact area
-  Free space



		
1	0,55m	7m <sup>2</sup>



1



01h30



0m<sup>3</sup>



7m<sup>2</sup>



31kg



10kg

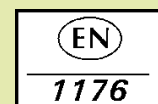

*Proludic*

2003-10-15