



2+



1



0,53m



1 = 0,95m 2 = 0,3m 3 = 0,9m

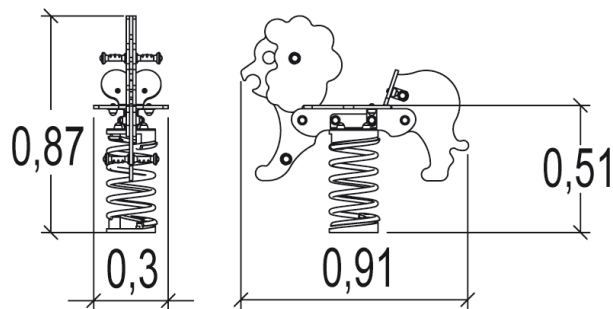

Play value

swinging



balancing



Accessibility



Motor disability

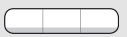

Sensorial Disabilities



Learning Disabilites



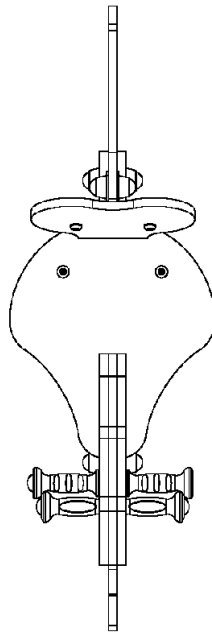



Installation of equipment

Impact area =

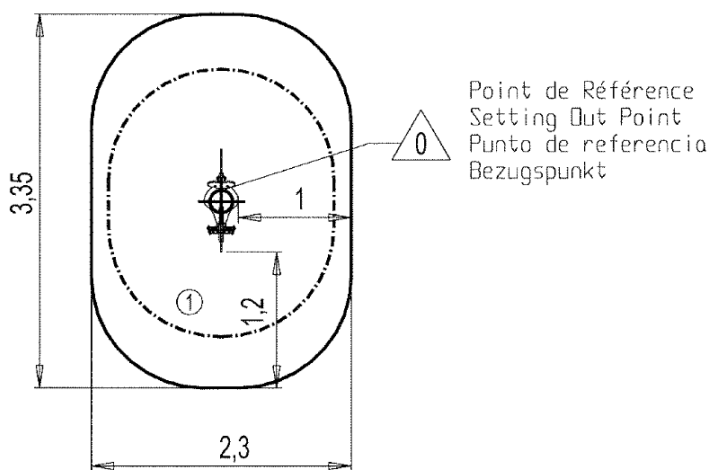
-  Impact area
-  Free space



		
1	0,53m	7m ²



1



01h00



0m³



7m²



30kg



10kg

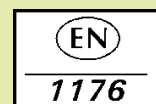

Proludic

2003-10-15