



1-5



1



0,46m



1 = 0,97m 2 = 0,39m 3 = 0,81m

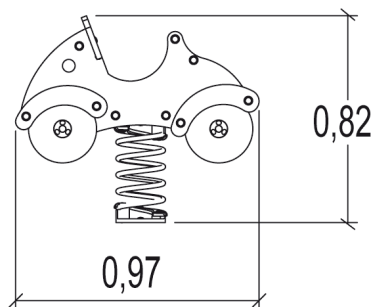
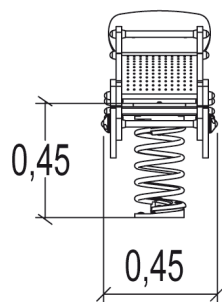

Play value

swinging



balancing



meeting / role play



Accessibility



Motor disability

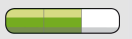

Sensorial Disabilities



Learning Disabilites



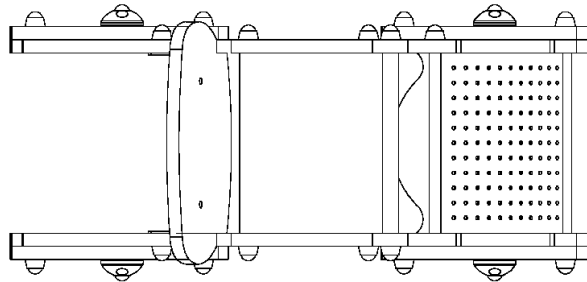



Installation of equipment

Impact area =

-  Impact area
-  Free space

	
1	0,46m
	7,5m ²

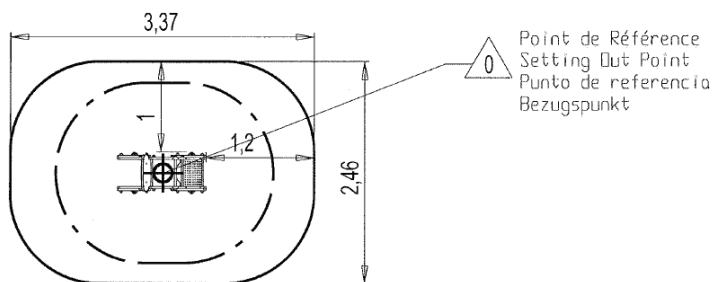

1



01h15



0m³



7.5m²



36kg



11kg

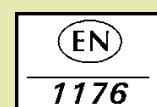

Proludic

2003-10-16