



2+



3



1m



1 = 3,6m 2 = 2,05m 3 = 3,3m

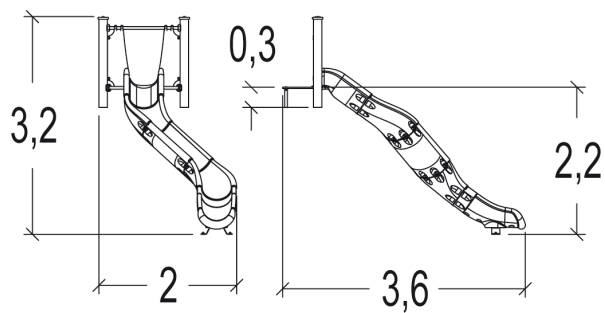

Play value

sliding



meeting / role play



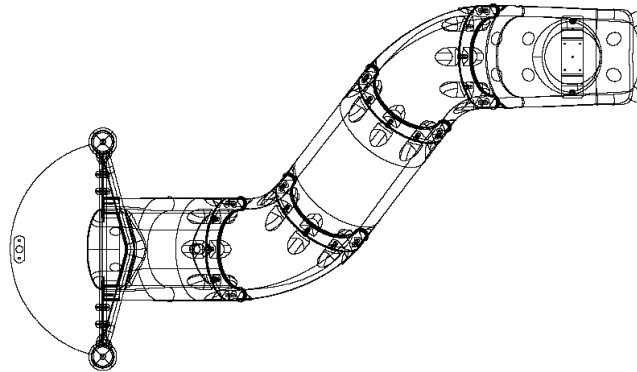



Installation of equipment

Impact area =

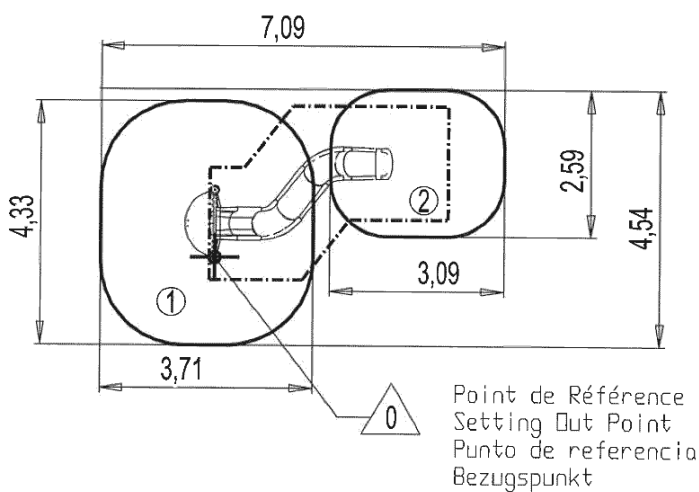
-  Impact area
-  Free space



		
1	<0,6m	14,5m ²
2	1m	7,5m ²



2



05h00



0.2m³



22m²



148kg



20kg



Proludic

2009-12-21