



2+



3



1m



1 = 6,4m 2 = 2,7m 3 = 5,5m

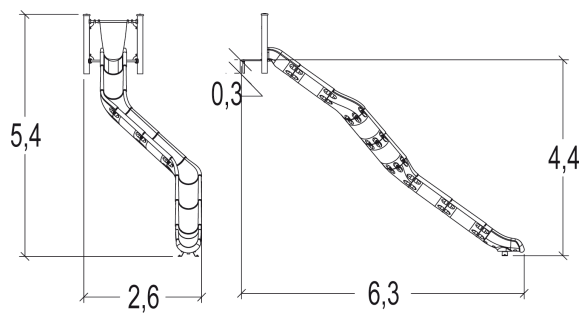

Play value

sliding



meeting / role
play



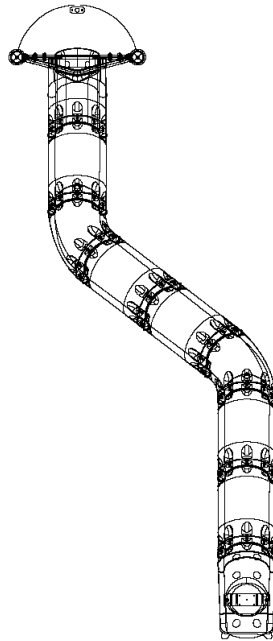



Installation of equipment

Impact area =

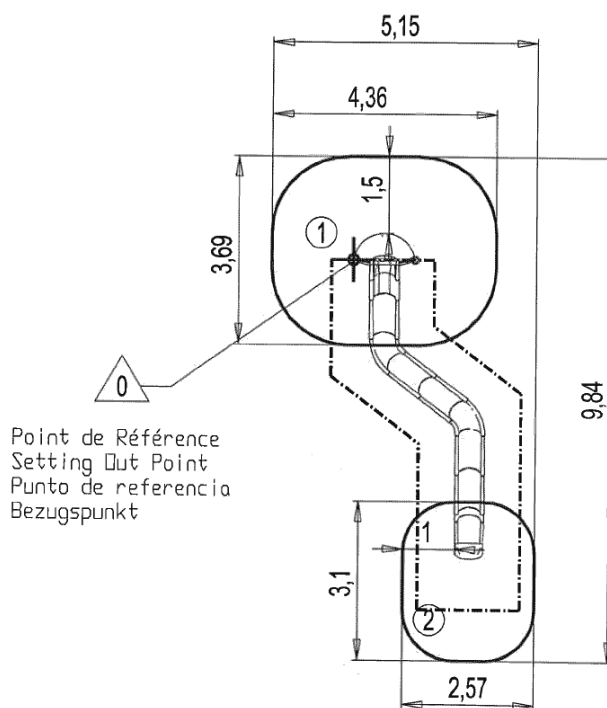
-  Impact area
-  Free space



		
1	<0,6m	14,5m ²
2	1m	7,5m ²



2



06h00



0.3m³



22m²



224kg



20kg

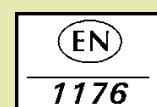

Proludic

2009-12-21