 1=5.4m 2=0.72m 3=3.4m

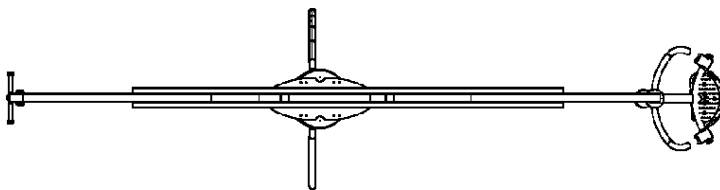

If installed onto wetpour safer surfacing, we recommend a NON-FINES CONCRETE BASE.

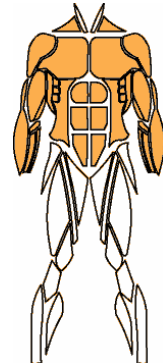

MUSCULAR STIMULATION



INTENSITY OF EFFORT



ENERGY EXPENDITURE

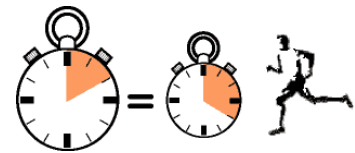

DIMENSIONS & MOVEMENTS

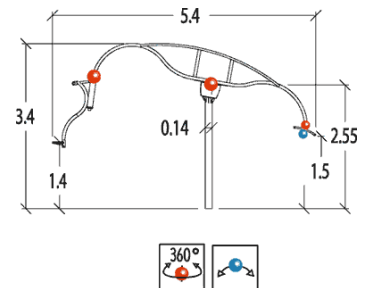

OTHER INFORMATION



2 players

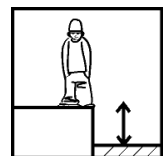

HCL= 2.35m

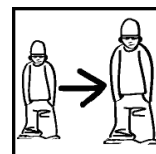

12+

Installation of equipment

Impact area =

———— Impact area

- - - - - Free space

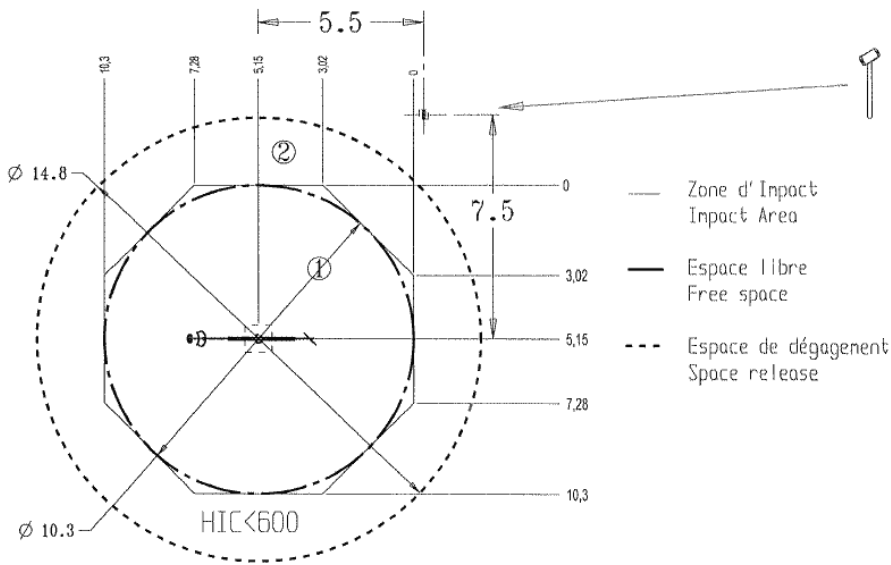

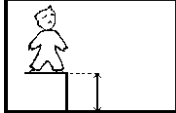
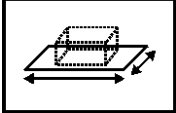
	
①	2.35m
②	<0.6m
	88m²
	84m²

Seat comprises 2 painted steel slats 50x25x2,5 mm, and 4 pultruded polyester slats (polyester composite/fibre gla

INSTALLATION



0.6m³



2

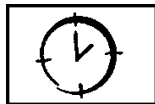

03h00



Lifting equipment
required

CERTIFICATIONS

