



2+



16



1,8m



1 = 3,1m 2 = 2,7m 3 = 2,7m

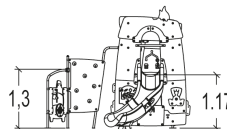
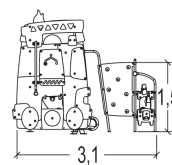
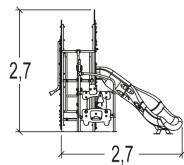
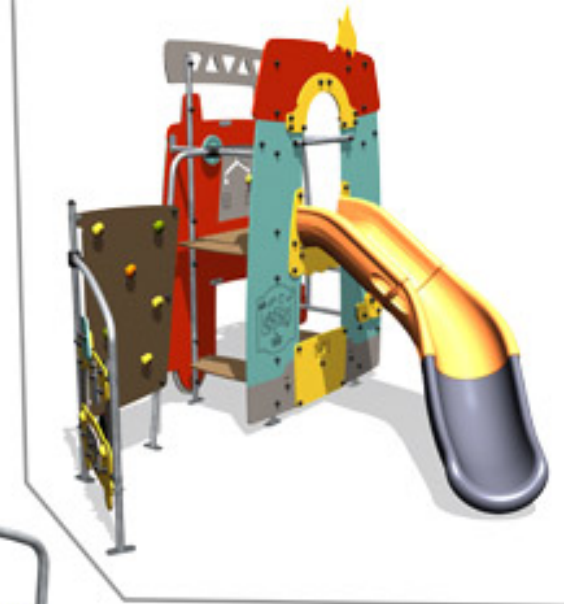

Play value

climbing



meeting / role play



sliding



hiding / resting



handling



Accessibility



Motor disability

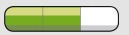

Sensorial Disabilities

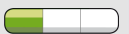

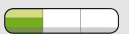

Learning Disabilites

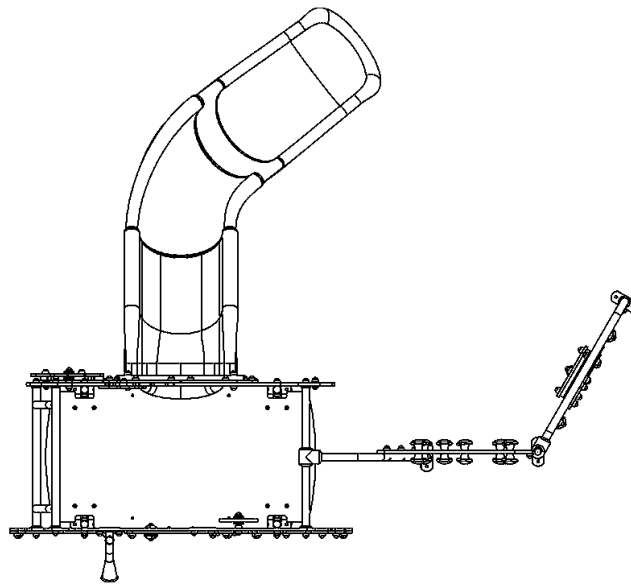





Installation of equipment

Impact area =

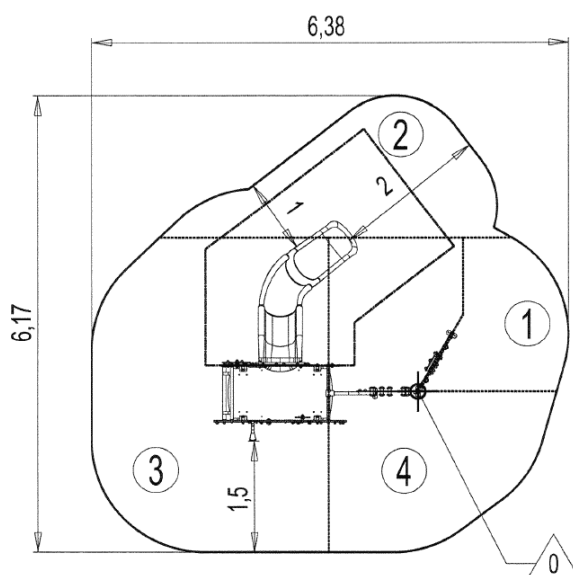
-  Impact area
-  Free space



		
1	0,6m	3m ²
2	1m	5,5m ²
3	1,17m	12,5m ²
4	1,8m	9m ²

Point de Référence
Setting Out Point
Punto de referencia
Bezugspunkt
Referentiepunt



2



00h00



0.3m³



30m²



293kg



24kg

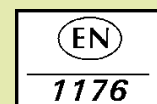

Proludic

2014-01-07