



3+



12



0,97m



1 = 3m 2 = 3m 3 = 2,6m

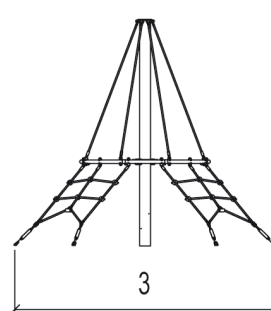
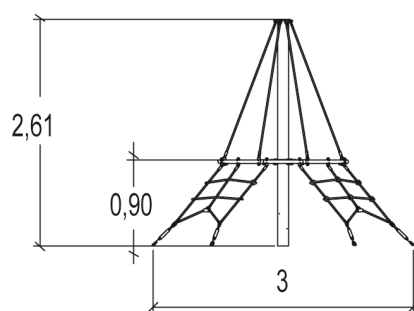

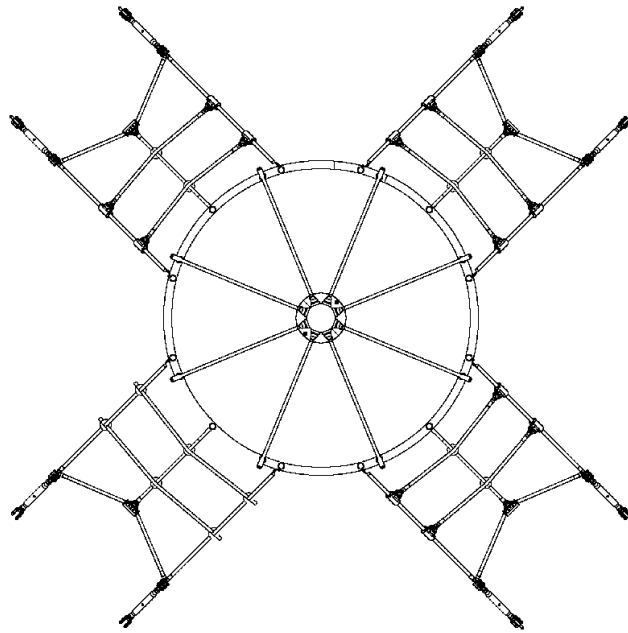



## Installation of equipment

Impact area =

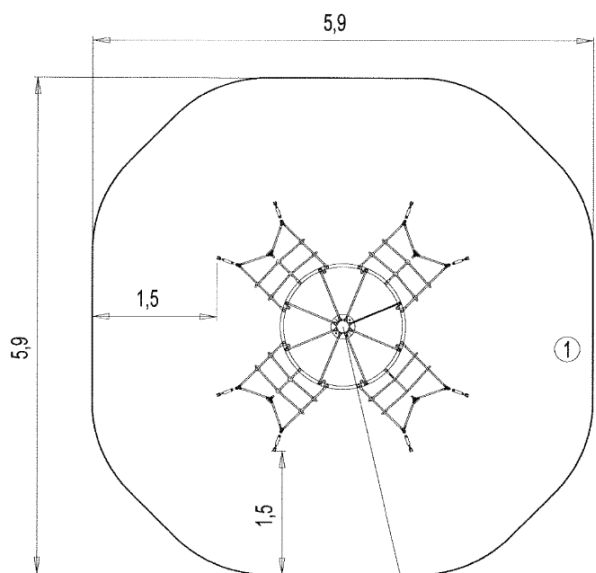
-  Impact area
-  Free space



① Point de Référence  
Setting Out Point  
Punto de referencia  
Bezugspunkt

|   |   |   |
|---|---|---|
|   |  |  |
| 1 | 0,97m   | 31m <sup>2</sup>  |



2



02h00



1m<sup>3</sup>



31m<sup>2</sup>



75kg



26kg

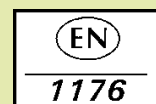

*Proludic*

2012-03-12