



2+



6



0,51m



1 = 1,45m 2 = 1,1m 3 = 1,35m

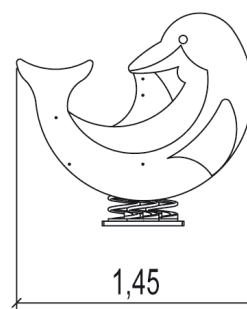
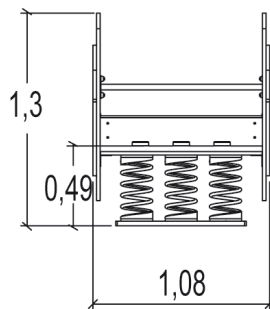

Play value

swinging



balancing



meeting / role play



Accessibility



Motor disability

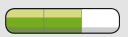

Sensorial Disabilities



Learning Disabilites



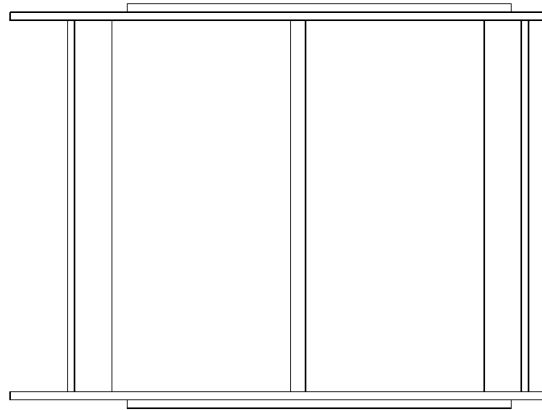



Installation of equipment

Impact area =

-  Impact area
-  Free space

		
1	0,51m	10,5m ²

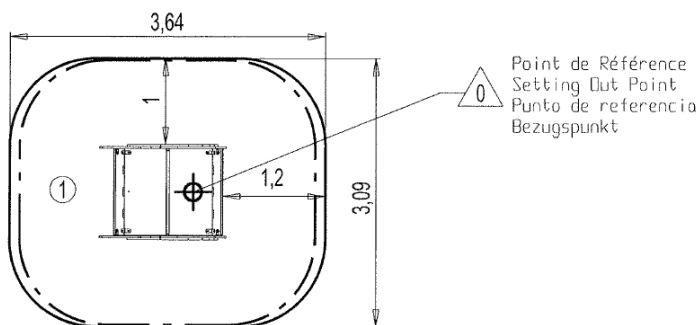

2



03h45



0m³



10.5m²



147kg



104kg

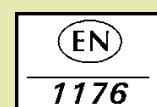

Proludic

2003-10-16