

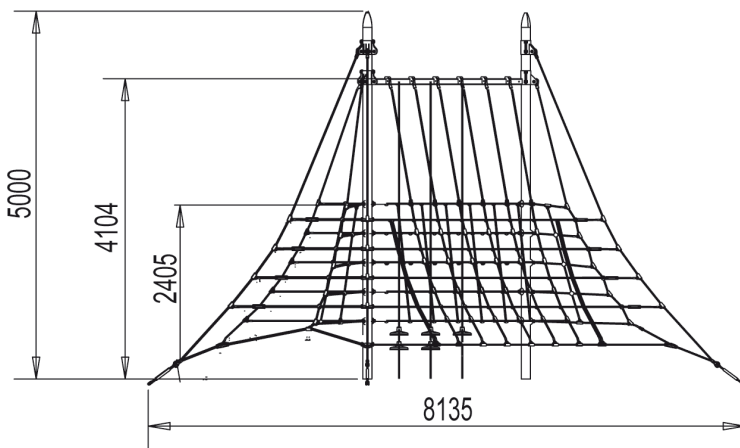

1=8.15m 2=9.4m 3=5m



OTHER INFORMATION



35 players

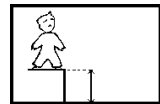

HCL= 2.4m

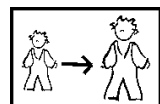

6+

Kaal = 501 kg

Raskeim detail = 41 kg

Installation of equipment

Impact area =

 Impact area

 Free space

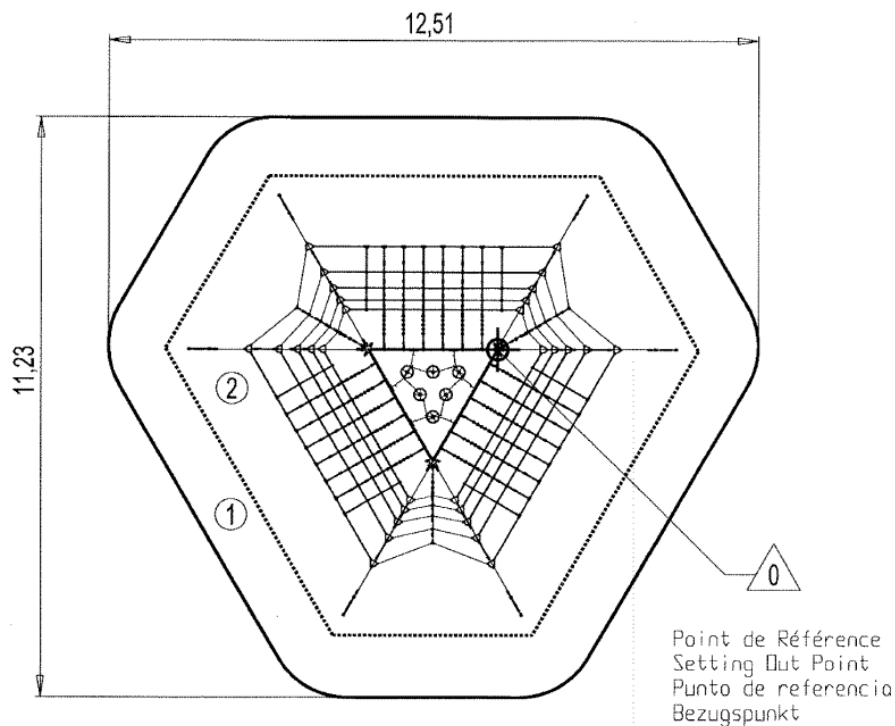

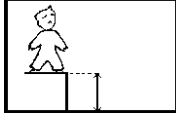
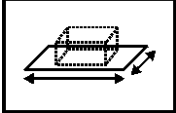
		
①	40m	1.5m ²
②	67m	2.4m ²

INSTALLATION

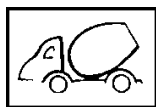

5.6m³



4

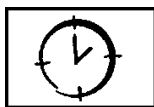

04h00

CERTIFICATIONS



Proludic