

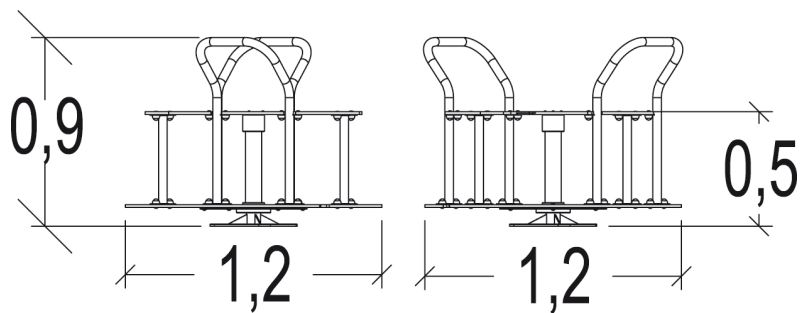

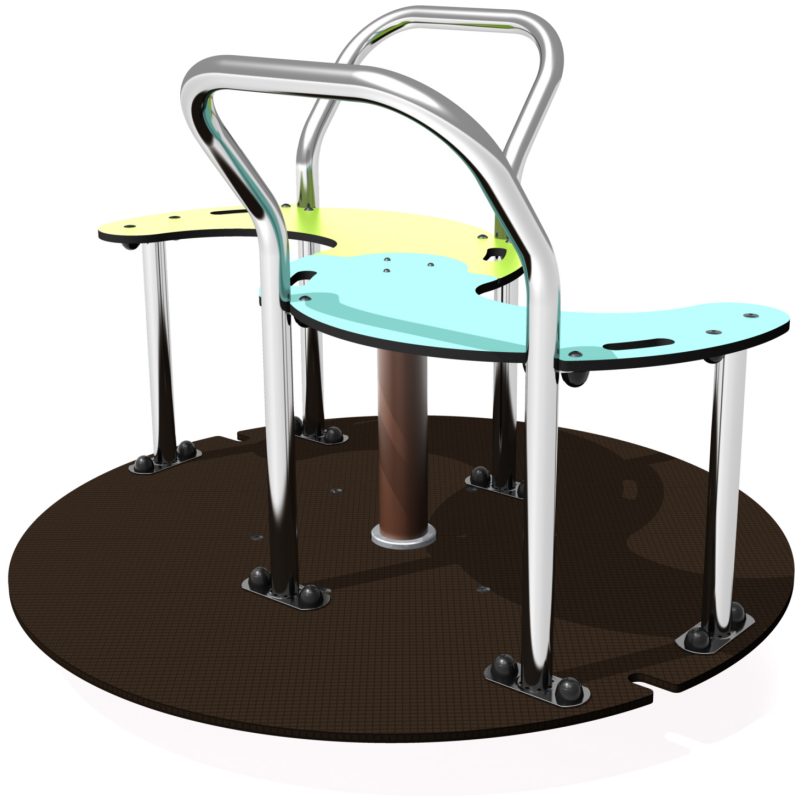

2+ | **6** | **1m** | **1 = 1,2m 2 = 1,2m 3 = 0,9m**



Play value

balancing 
 meeting / role play 
 rotating 

Accessibility

 Motor disability

 Sensorial Disabilities

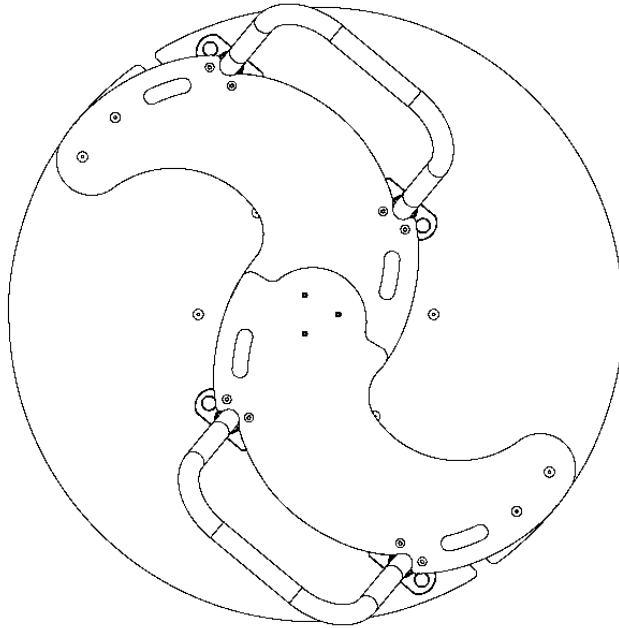

 Learning Disabilites







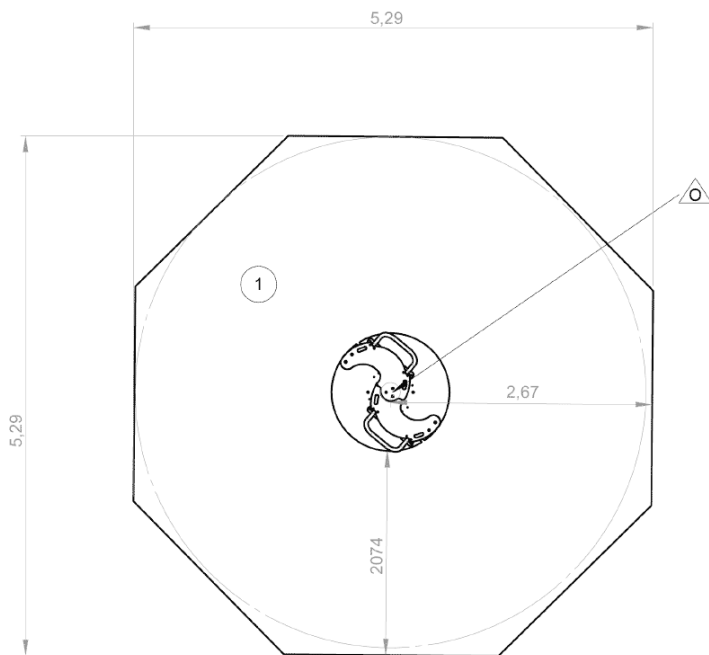





Installation of equipment

Impact area =

-  Impact area
-  Free space

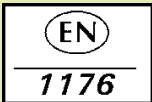

		
1	1m	23m ²

							
1	03h00	0.3m ³	23m ²	87kg	37kg		2015-07-31