



2+



5



1m



1 = 1,2m 2 = 1,2m 3 = 0,9m

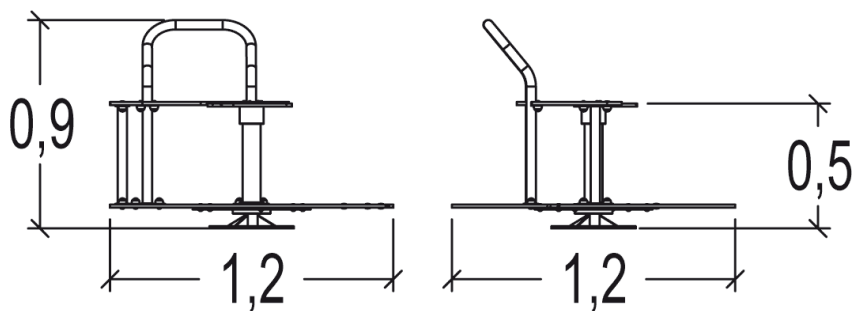
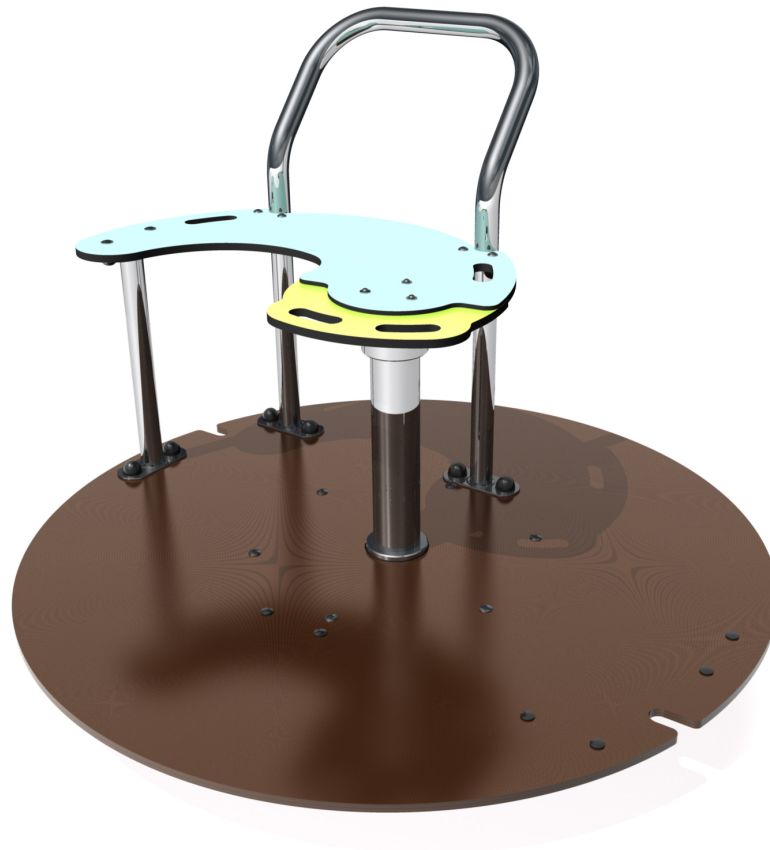

Play value

balancing



meeting / role play



rotating



Accessibility



Motor disability



Sensorial Disabilities



Learning Disabilites



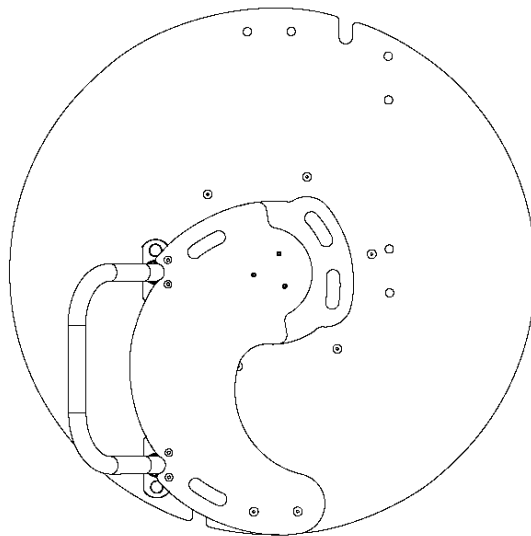







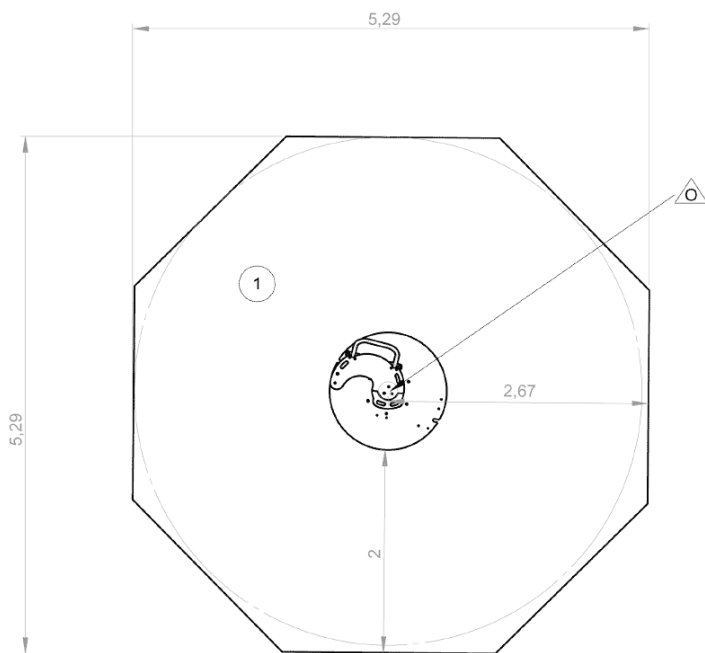



Installation of equipment

Impact area =

-  Impact area
-  Free space

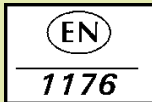

| | |
|---|---|
|  |  |
| 1 | 1m |
| | 23m ² |

| | | | | | | | |
|--|---|---|---|---|---|---|---|
|  |  |  |  |  |  |  |  |
| 1 | 03h00 | 0.3m ³ | 23m ² | 79kg | 37kg | | 2015-07-31 |