



1+



2



1,5m



1 = 3,68m 2 = 1,8m 3 = 3m



Motor disabilities
 Sensorial disabilities
 Learning disabilities

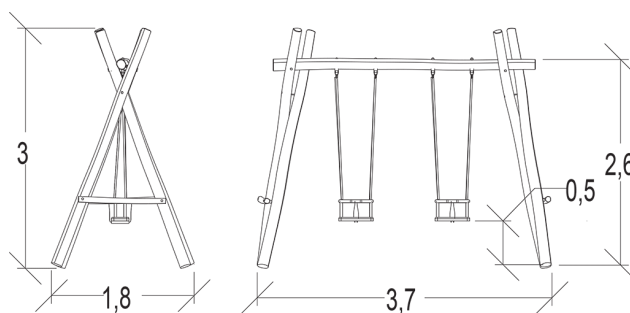
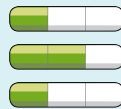

Play value : 3

swinging



meeting



resting



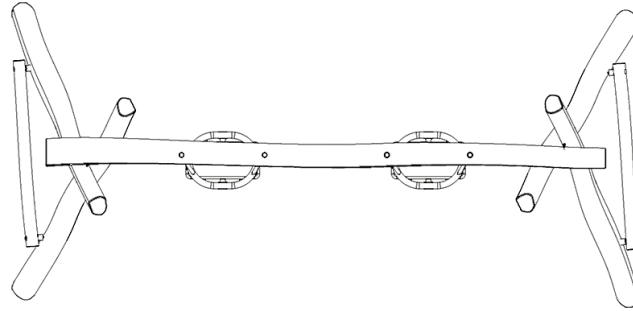

Installation of equipment

Impact area =



-  Impact area
-  Free space









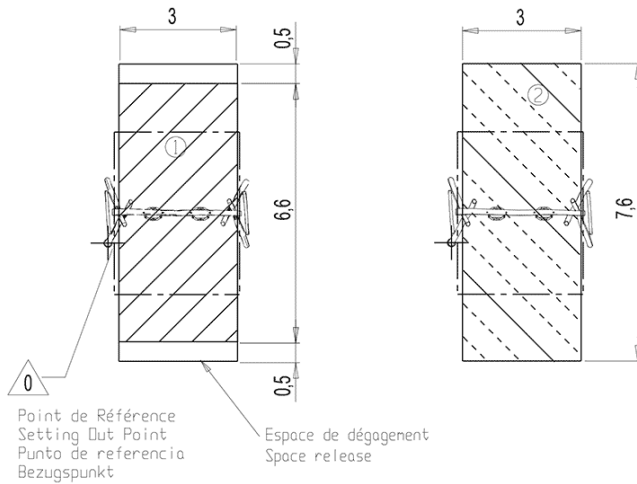

Zone d'Impact Sol souple
Impact Area Wetpour
Area de Impacto
Fallraum bei synthetischen Fallschutz



Zone d'Impact Sol fluent
Impact Area Loose particle material
Arenero
Fallraum bei losen Bodenmaterial

		
1	1,5m	20m ²
2	1,5m	23m ²

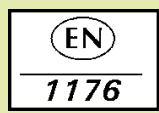

							
2	01h30	0.11m ³	20m ²	263kg	46kg		0000-00-00