

5 59 159 0110 0

climbo play unit Off-Road





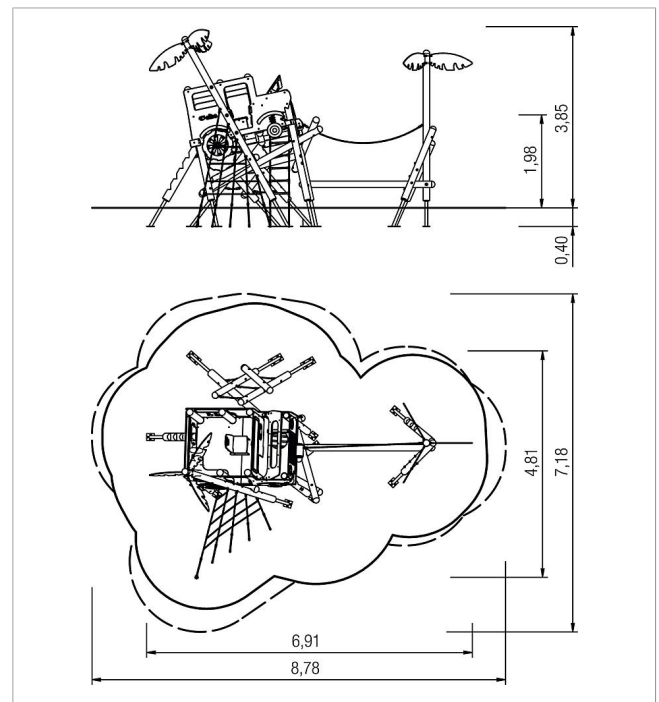

made in germany

5+

Scope of delivery

20x post construction: softwood
 13x post shoes: galvanized steel
 1x post construction: softwood
 1x trunk ascent: softwood
 2x log ascent: softwood
 1x balance beam: softwood
 1x net ascent sloped: plastic-coated steel rope
 1x rope ladder: plastic-coated steel rope
 1x zig-zag ascent: softwood, plastic-coated steel rope
 2x side panel with wheel: high-pressure laminate (HPL)
 1x side panel rear wheel: high-pressure laminate (HPL), softwood
 1x side panel front: high-pressure laminate (HPL), Makrolon
 1x bonnet: high-pressure laminate (HPL), softwood
 1x driver seat: high-pressure laminate (HPL)
 1x bench: high-pressure laminate (HPL)
 1x dashboard: high-pressure laminate, softwood
 1 x cable winch with hand rope: high-pressure laminate (HPL), softwood, plastic-coated steel rope
 6x palm leaf decoration: high-pressure laminate (HPL)
 fittings: stainless steel (V2A)



	Material	SW pi
	Foundation level	FL 1
	Minimum space	878x718x385 cm
	Free falling height	198 cm
	Impact protection net	38,0 m ²
	Foundations	2x CF
	Largest section	Ø14x469 cm