

5 10 038 0411 0

playo sand building site Little Woodpecker







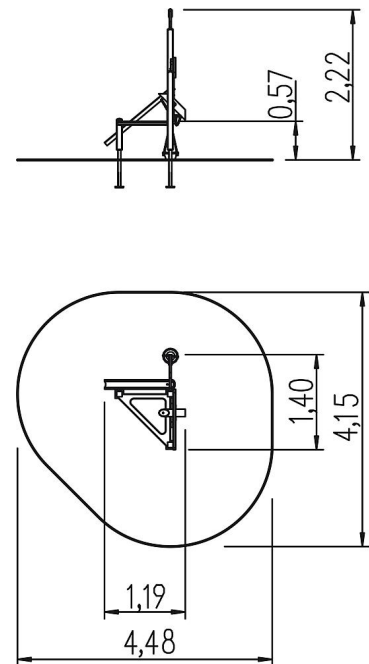

made in germany

2+

Scope of delivery

set of posts with post bases: SW, galvanised steel
platform with sifter insert: SW, stainless steel
sand crane: stainless steel, PAH-free rubber
sand chute: SW
sand pouring pipe: plastic, HPL, SW
mounting accessories, article passport



	Material	Larch GL, larch
	Foundation level	FL 1
	Minimum space	448x415x222 cm
	Free falling height	57 cm
	Impact protection net	14,5 m ²
	Foundations	3x CF or 3x PFs
	Assembly	2 persons/2.5 h
	Largest section	75x75x6 cm
	Heaviest section	10 kg