

 **2+**  
 **2**  
 **0,7m**

  
 1 = 1,48m  
 2 = 0,53m  
 3 = 0,73m



Physical inclusion  
Sensory inclusion  
Cognitive inclusion

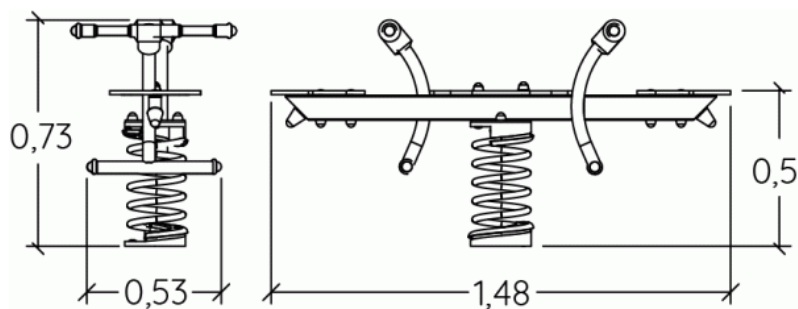

**Play value :** **4**

role play



x1

meeting



x1

balancing



x1

Oscillate



x1



## Installation of equipment

**IMPORTANT:** It is essential to refer to the installation instructions for information on the size of the safety areas.

 Impact area (minimum normative surface)

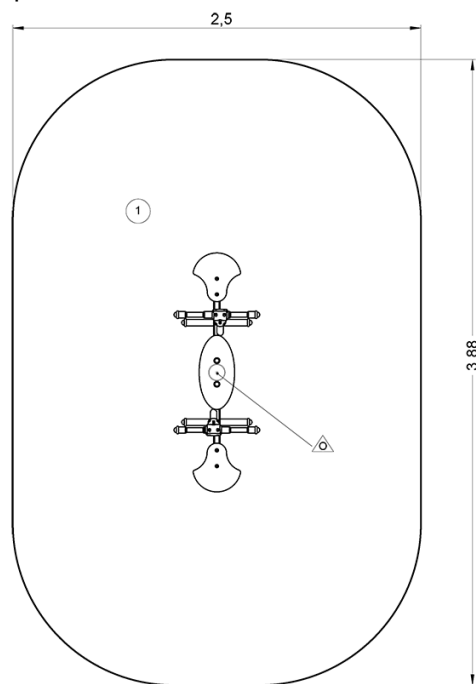
 Free space



		
1	0,7m	9m <sup>2</sup>



1



01h15



0m<sup>3</sup>



9m<sup>2</sup>



35kg



19kg

EN

1176