

SOCIALIZING



SLIDING



CLIMBING



SENSORIAL
INTEGRATION



INFORMATION ABOUT THE PRODUCT

Dimensions	ca.811 x 582 cm
Safety zone	ca.1161 x 882 cm
Overall height	ca.412 cm
Free fall height	ca.150 cm
Amount of users	21 person
Product complies with PN-EN 1176-1:2017-12	YES
Availability of spare parts	YES
Age range	3-12
<small>According to EN 1176-1:2017-12 norm, the product requires applying a safety surface according to the product's free fall height.</small>	





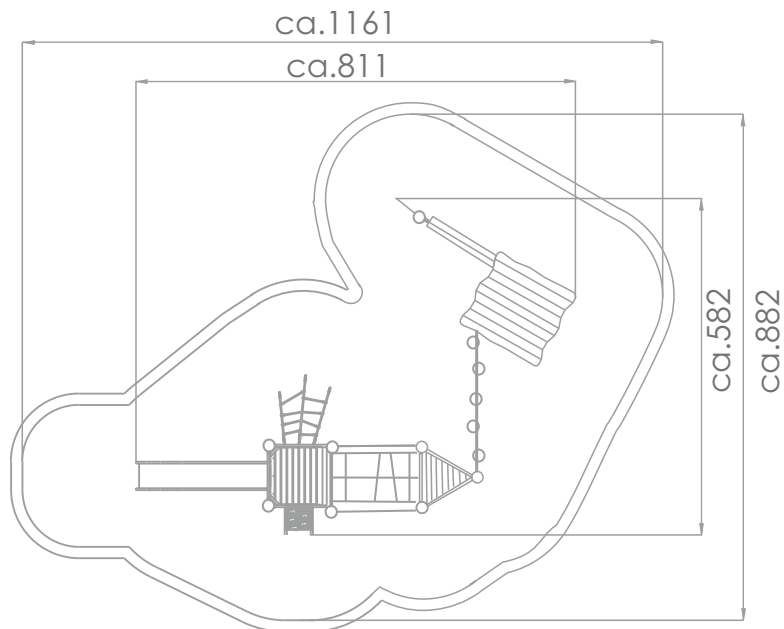
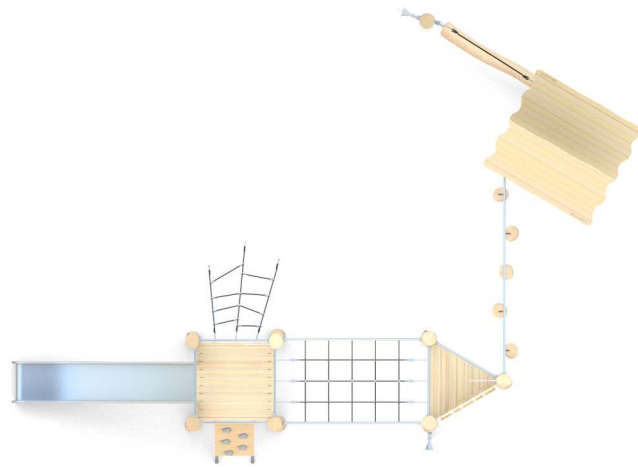

Visualisation is for reference only,
actual appearance may vary.



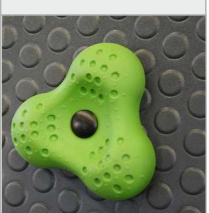
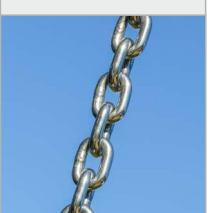

SCALE 1:125

MATERIALS:

<p>NATURAL ROBINIA WOOD</p> 	<p>ELEMENTS CONSTRUCTION MADE OF STAINLESS STEEL AISI 304</p> 	<p>PLATES OF THE WALLS MADE OF GREY TRIPLE LAYERED 15 MM HDPE POLYETHYLENE</p> 	<p>SLIDES MADE OF STAINLESS STEEL AISI 304</p> 	
<p>CLIMBING ROCKS MADE OF CHIPPINGS AND COLOURFUL POLYESTER RESIN</p> 	<p>ATTESTED 6 MM STAINLESS STEEL CHAINS</p> 	<p>POLYPROPYLENE ROPES PP - MULTISPLIT TYPE WITH A STEEL CORE AND A DIAMETER OF 16 MM</p> 	<p>ROPE ENDINGS PRESSED IN A SLEEVE MADE OF DURABLE ALUMINUM ALLOY</p> 	<p>SOLID AND ESTHETIC ROPE CONNECTORS MADE OF INJECTION MOLDED POLYAMIDE</p> 