

5 25 708 1539 1

tough trail
Kletterelement
Climbing Cube
made in germany

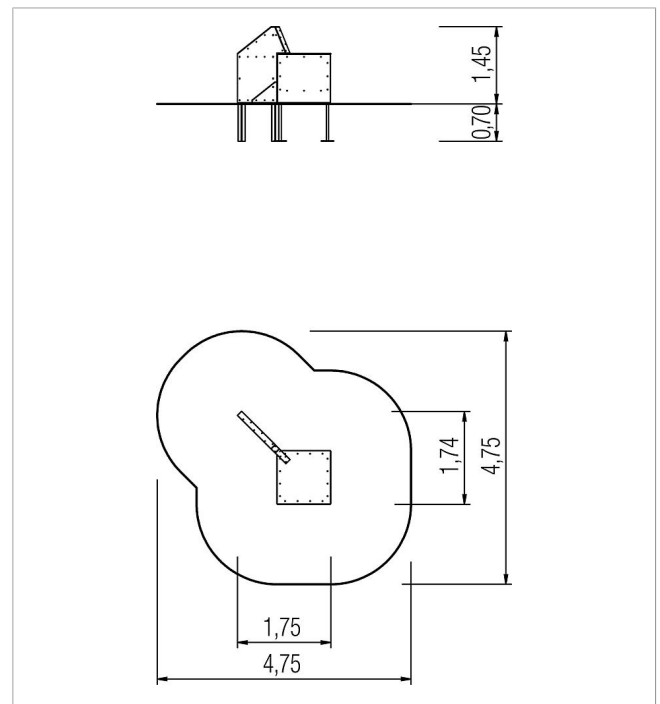

Scope of delivery



	Material	HPL
	Foundation level	FL 3
	Minimum space	474x474x325 cm
	Free falling height	145 cm
	Impact protection net	17,0 m ²
	Foundations	5x CF