

5 66 458 120 00

Basis Water play unit Niagara







made in germany

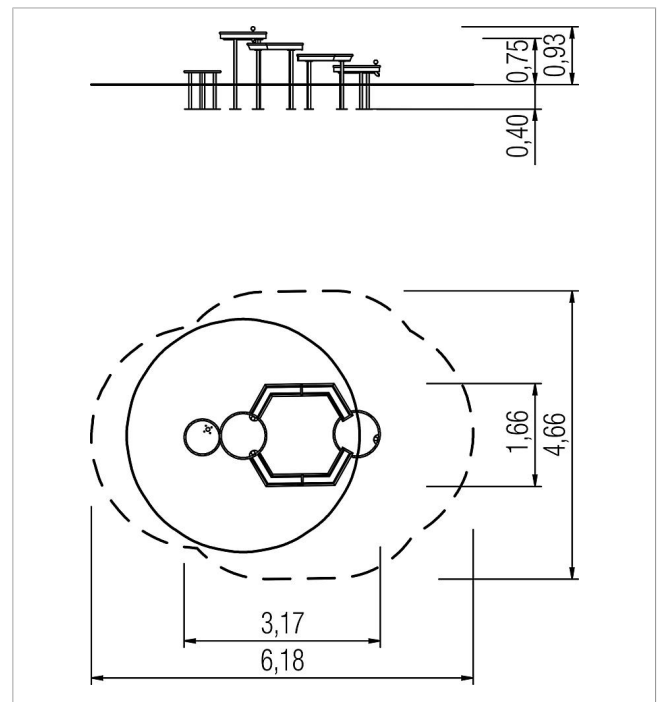

Scope of delivery

- 1x pump platform: stainless steel
- 2x valve basin round with 1 valve: stainless steel
- 2x trough bent left: stainless steel
- 2x trough bent right: stainless steel



	Material	Stainless steel
	Foundation level	ET 400
	Minimum space	4,66x6,20x2,55 m
	Free falling height	75 cm
	Impact protection net	11,5 m ²
	Foundations	5x CF or 10x PFs
	Assembly	2 persons/3 h