



14+



9



1,7m



1 = 5,26m
2 = 3,26m
3 = 2,32m



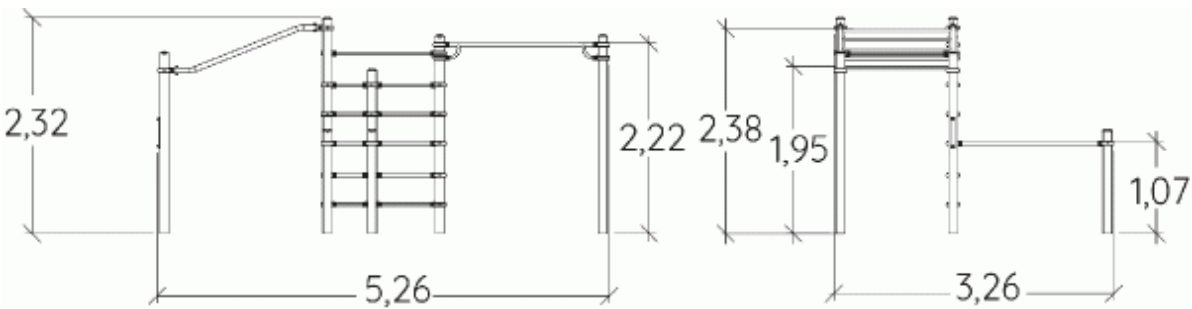
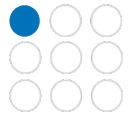

Motor inclusion
Sensory inclusion
Mental inclusion





Installation of equipment

IMPORTANT: It is essential to refer to the installation instructions for information on the size of the safety areas.

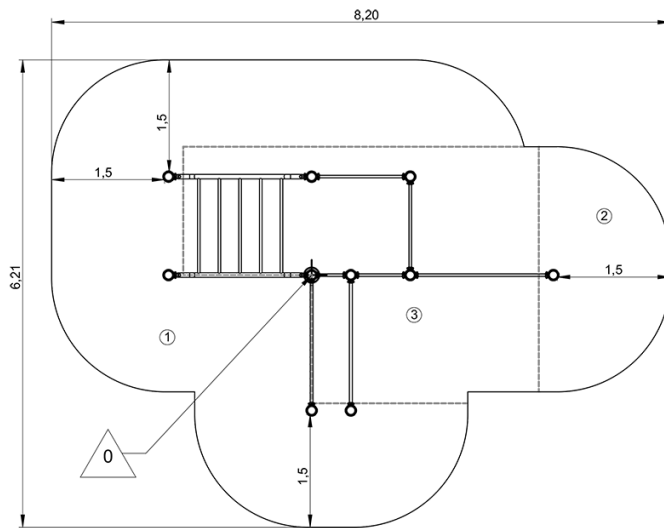
-  Impact area (minimum normative surface)
-  Free space



		
1	1,1m	20m ²
2	1,2m	5m ²
3	1,7m	13m ²



3



05h00



1.5m³



38m²



284kg



22kg

