



14+



11



2m



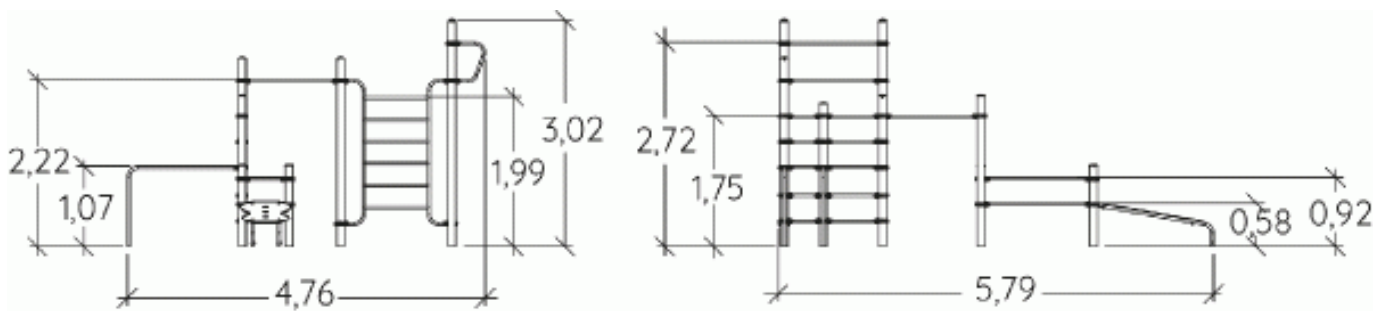
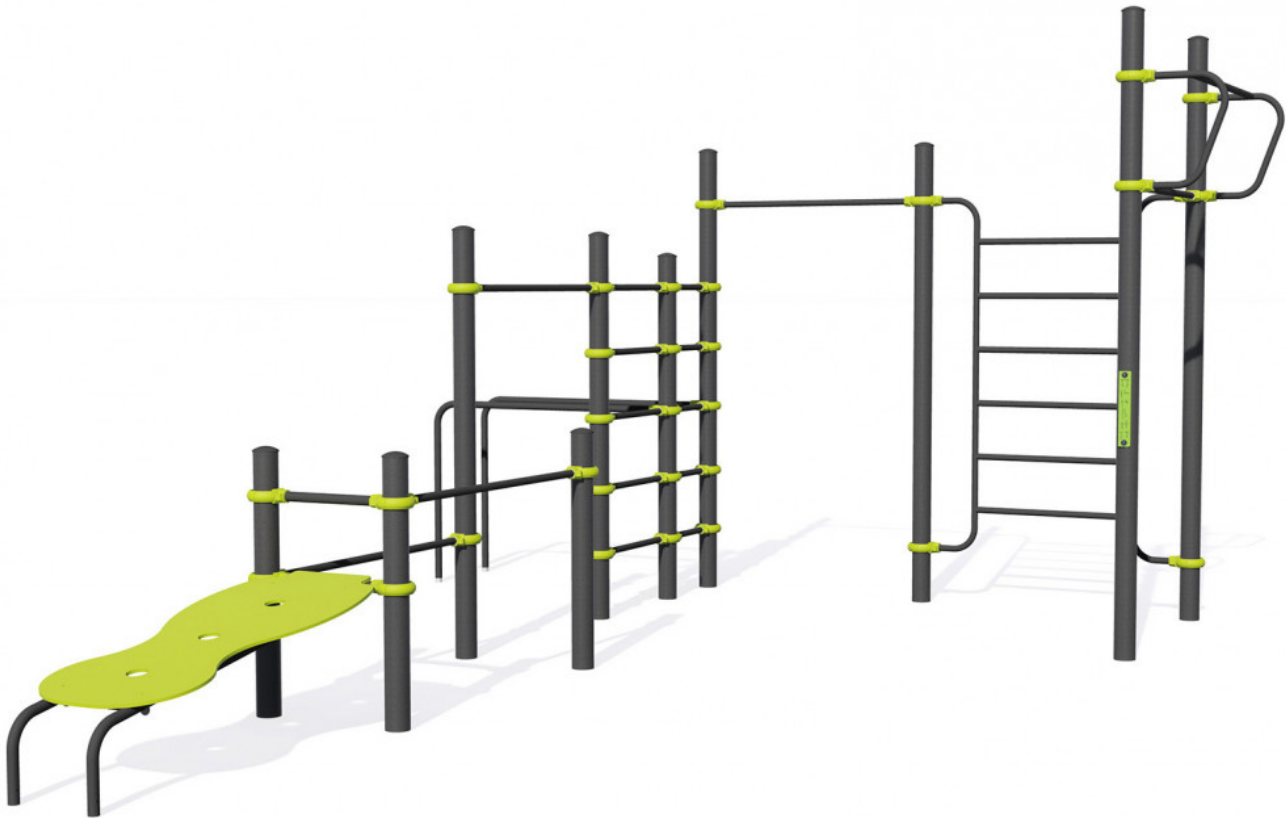

1 = 5,79m
2 = 4,76m
3 = 3,02m





Installation of equipment

IMPORTANT: It is essential to refer to the installation instructions for information on the size of the safety areas.

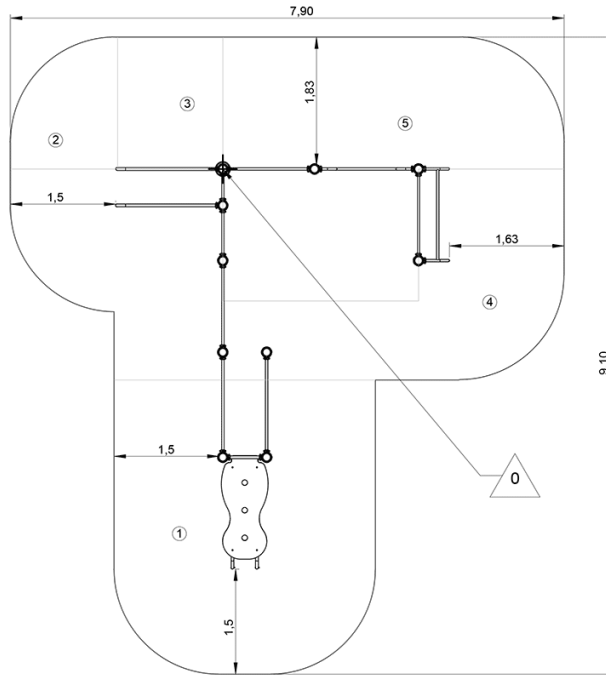
-  Impact area (minimum normative surface)
-  Free space



		
1	0,95m	15m ²
2	1,1m	2,5m ²
3	1,2m	3m ²
4	1,7m	16,5m ²
5	2m	14m ²



2



07h00



1.9m³



51m²



323kg



28kg

