

 **2+**
 **25**
 **1,17m**
 1 = 8,1m
2 = 4,5m
3 = 4,4m



Motor inclusion
Sensory inclusion
Mental inclusion



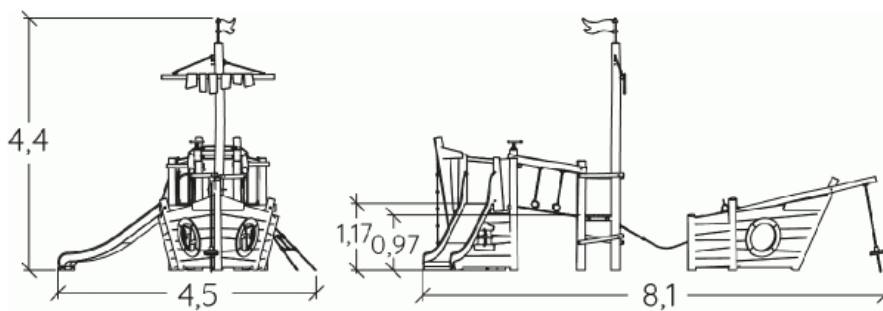
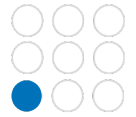

Play value : **20**



role play  x1	sliding  x1	meeting  x2	resting  x3	handling  x2	hanging  x1	hiding  x1	balancing  x3
taking shelter  x1	tactile stimulation  x1	visual stimulation  x1	climbing  x2	getting across  x1			

Installation of equipment

IMPORTANT: It is essential to refer to the installation instructions for information on the size of the safety areas.

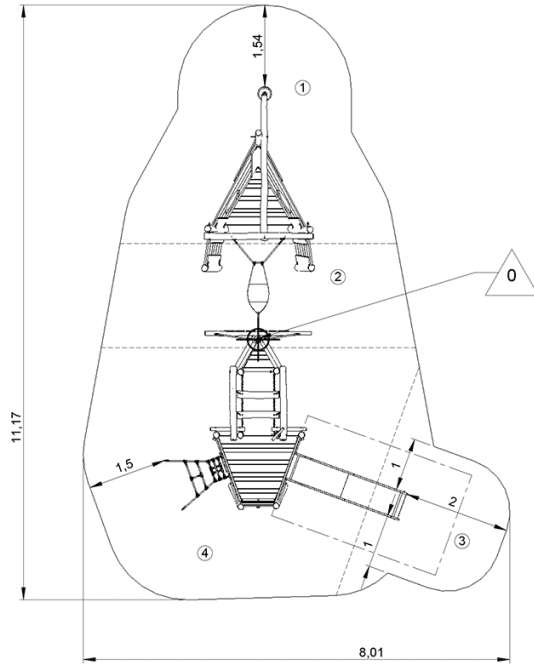
-  Impact area (minimum normative surface)
-  Free space



		
1	1,17m	59m ²



2



30h00



0.65m³



59.5m²



983kg



883kg

