

5 55 652 0

Basis Seat and rest rock Fichtelgebirge

made in germany









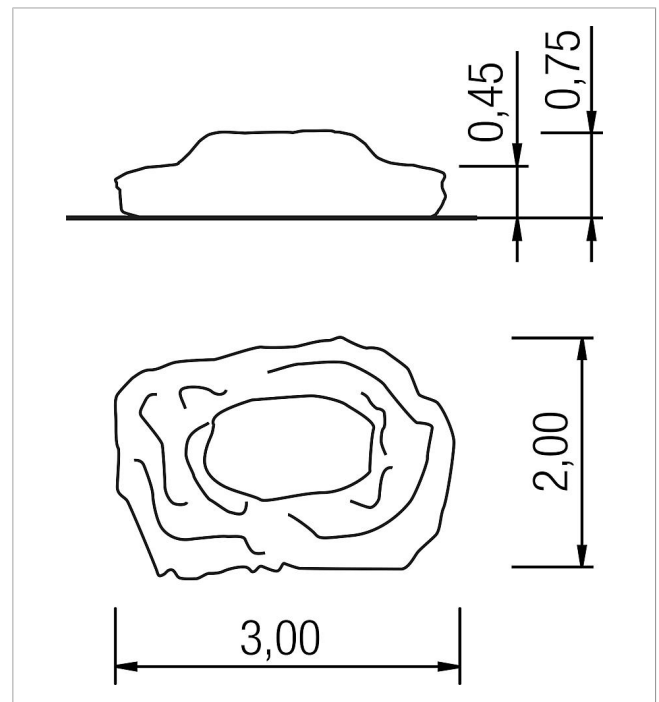

3+

Scope of delivery

1x seat and rest rock: styrofoam, modelling matrix



	Material	Styrofoam, modelling matrix
	Foundation level	FL 1
	Minimum space	200x100 cm
	Free falling height	45 cm
	Impact protection net	-
	Foundations	-
	Assembly	2 persons/1 h
	Largest section	200x100x45 cm
	Heaviest section	1.000 kg