

5 67 243 0

Basis Spring rocker Horse







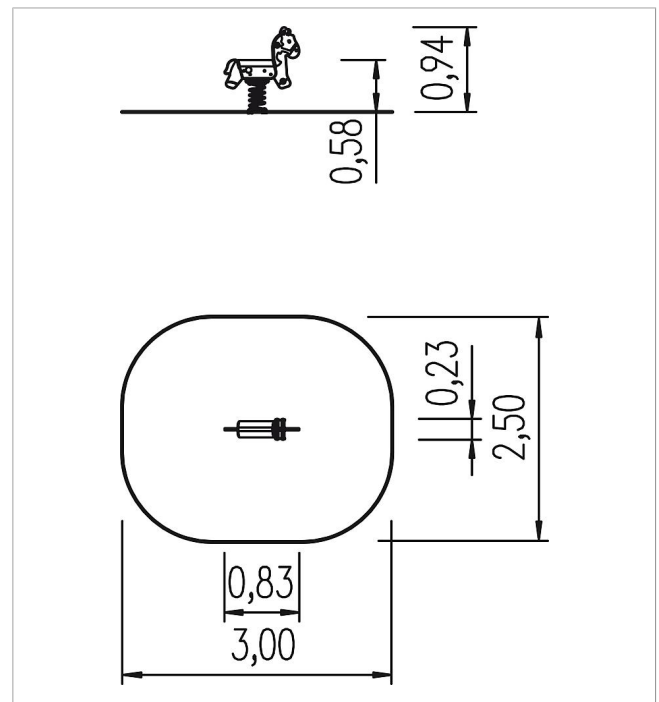

made in germany



Scope of delivery

1x spring rocker body: laminated wood, MDF exterior
1x spring: spring steel



	Material	Laminated timber, MDF
	Foundation level	FL 0
	Minimum space	300x250x238 cm
	Free falling height	58 cm
	Impact protection net	7,0 m ²
	Foundations	1x 5591600 + 1x CF or 1x 5632100 + 1x CF
	Assembly	1 person/1 h
	Largest section	83x68x23 cm
	Heaviest section	10 kg